

**Catalogo 2017/2018**

**Componenti elettrici ed elettronici**

Electric and electronic components

**Relè - Lampeggiatori**



 **MAGNA**  
**MAGNA ELECTRONICS**

 **BLOCK  
STEM**

 **S.I.D.A.T.**

**VDO**

**LIFT  
TEK**

 **ELECTRIC-LIFE**  
TOTAL QUALITY











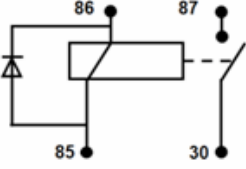

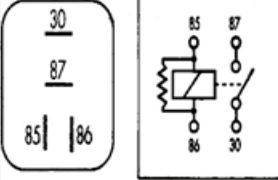

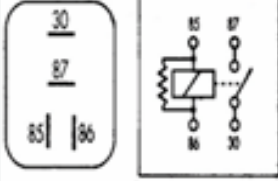
**MAGNETI  
MARELLI** **RICAM**

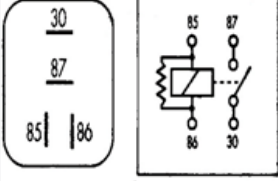

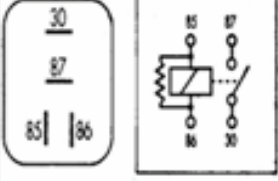

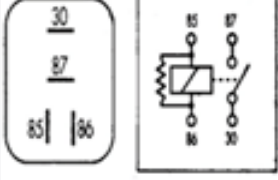

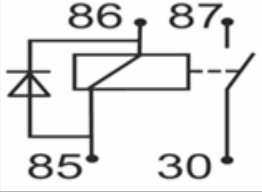

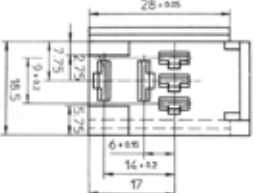

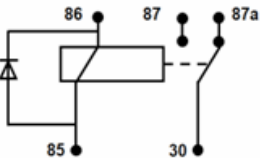

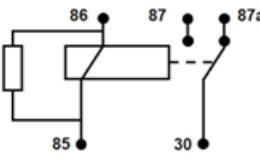

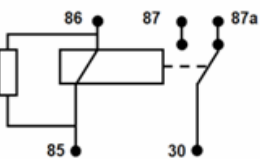
Microrelè 12V NA	1
Microrelè 12V NC	2
Minirelè iso 12V NA	3
Minirelè iso 12V NC	4
Maxirelè 12V NA	5
Maxirelè 12V NC	7
Lampeggiatori 12V	8
Portarelè	10
Centraline preriscaldamento 12V	11
Relè stagni combinati	14
Contenitore diodi	15
Unità bloccaporte	17
Temporizzatori	19
Intermettitori	20
Dispositivi elettronici	21
Accendini	25

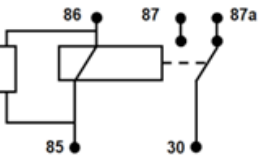

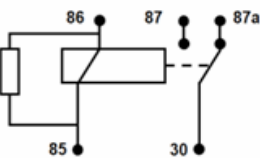

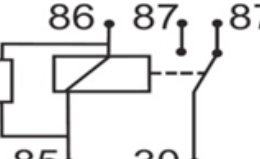



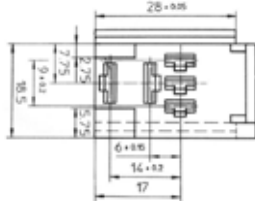

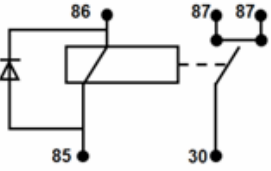
## Truck Parts

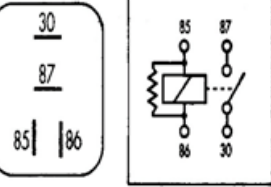

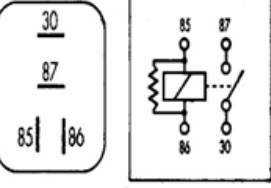



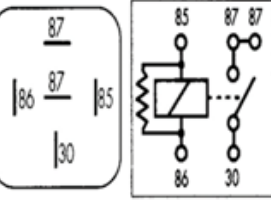

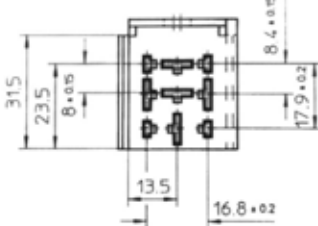

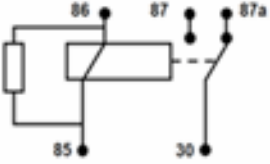

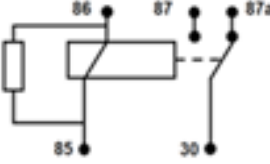
Applicazioni veicoli industriali	26
Riduttori di tensione	28
Lampeggiatori	29
Devio	30
Contenitore diodi	34
Portaresistori	35
Dispositivi elettronici	36
Microrelè 24V	37
Maxirelè 24V NA	38
Maxirelè 24V NC	39
Minirelè iso 24V NA	40
Minirelè iso 24V NC	41

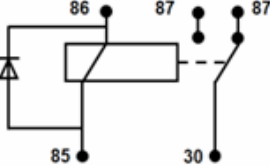

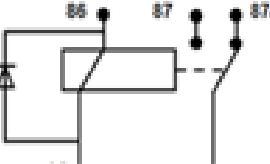

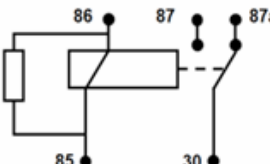

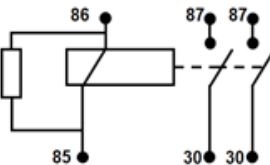
	<b>FB220.N42</b> 	25 Amp c/Diodo s/Staffa
	<b>FB702.23</b> 	30 Amp c/Resistenza s/Staffa 500029005
	<b>FB702.30</b> 	25 Amp c/Diodo s/Staffa
	<b>FB702.50NT</b> 	30 Amp c/Resistenza s/Staffa 500029005
	<b>FB702.50CS</b> 	30 Amp c/Resistenza c/Staffa
	<b>FB702.80</b> 	25 Amp c/Resistenza s/Staffa Faston Piccoli 2,8mm
	<b>FB702.80CD</b> 	25 Amp c/Diodo s/Staffa Faston Piccoli 2,8mm
	<b>FB10700004</b> Stecksocket Socket	<b>Porta Microrelè</b> 

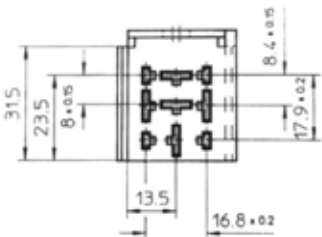
	<p><b>FB222.C52</b></p>	<p>15/25 Amp c/Diodo s/Staffa</p>
		<p>SEALED Bosch 0 332207104 Bosch 0 29201075</p>
	<p><b>FB29201075</b></p>	<p>15/25 Amp c/Resistenza s/Staffa</p>
		<p>Bosch 0 332 207 100 Bosch 0 332 207 307 Opel 90414477 90511443 John Deere AL76702</p>
	<p><b>FB677.30NT</b></p>	<p>10/20 Amp c/Resistenza s/Staffa</p>
		
	<p><b>FB677.50</b></p>	<p>10/20 Amp c/Resistenza s/Staffa</p>
		
	<p><b>FB677.61</b></p>	<p>15/25 Amp c/Diodo s/Staffa</p>
		<p>504049024</p>
	<p><b>FB677.80</b></p>	<p>20 Amp c/Resistenza s/Staffa</p>
		<p>Faston Piccoli 2,8mm</p>









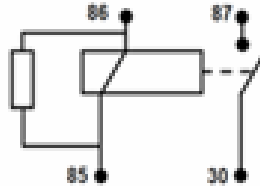

	<p><b>FB10700004</b></p>	<p>Porta Microrelè</p>
	<p>Stecksocket Socket</p>	

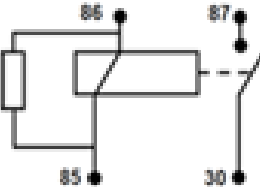

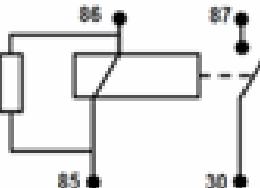

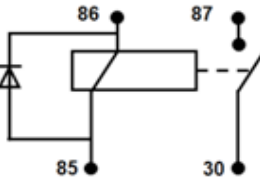

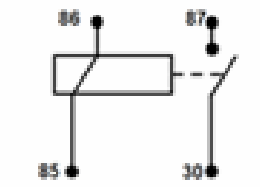

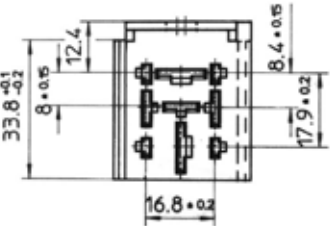
	<b>FB221CS</b> 	<b>40 Amp c/Diodo c/Staffa</b>
	<b>FB609A</b> 	<b>30 Amp c/Resistenza c/Staffa Fusibile 15A</b> Bosch 0332019451 Hella 4RA003 510-361 Opel 1238587-90008100
	<b>FB1113</b> 	<b>40 Amp c/Resistenza c/Diodo s/Staffa</b> Relè tenuta stagna
	<b>FBCABL1112</b>	<b>Cablaggio per : FB1111 - FB1112 - FB1113</b> Cablaggio tenuta stagna
	<b>FB1111 + FBCABL1112</b>	<b>Kit tenuta stagna</b>
	<b>FB520.40RES</b> 	<b>40 Amp c/Resistenza c/Staffa</b>
	<b>FB10485008</b> Stecksocket Socket	<b>Portarelè iso</b> 

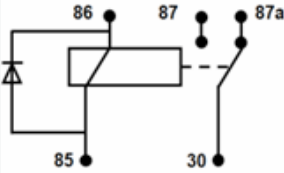

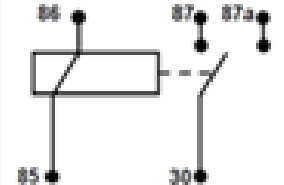

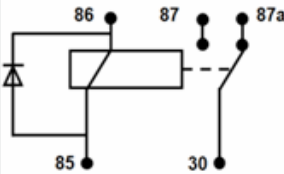

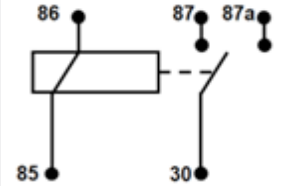

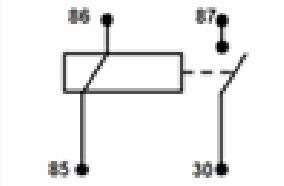

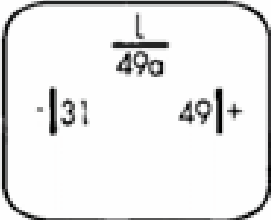
	<p><b>FB101RES</b></p> 	<p><b>30/40 Amp c/Resistenza s/Staffa</b></p> <p>Bosch 0332 204 109 0332 209137-138-159-161-167                  Hella 4RD003520-241                  VAG 141 951 253B                  VAG 431951253H                  8D0 951 253 A</p>
	<p><b>FB1111</b></p> 	<p><b>30/40 Amp c/Diodo c/Staffa</b></p> <p>Relè tenuta stagna</p>
	<p><b>FB1112</b></p> 	<p><b>30/40 Amp c/Diodo c/Staffa</b></p> <p>Relè tenuta stagna</p>
	<p><b>FB101240CD</b></p> 	<p><b>30/40 Amp c/Diodo c/Staffa</b></p> <p>Bosch 0 332 209 135-0 332 208 152-0 332 209 158                  Iveco 5158609--99434621                  Volvo 1 324 492</p>
	<p><b>FB690.50</b></p> 	<p><b>20/40 Amp c/Resistenza s/Staffa</b></p> <p>504053414                  Applicazione Iveco 5040534214</p>
	<p><b>FB063</b></p> 	<p><b>30 Amp c/Resistenza</b></p> <p>NA doppio contatto</p>
	<p><b>FB10485008</b> <b>Portarele iso</b></p> <p>Stecksocket                  Socket</p> 	

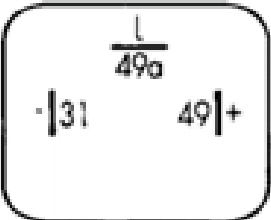
	<b>FB100.12N</b>	100 Amp
	<b>FB120/180</b>	120 Amp
	<b>FB200/300</b>	200 Amp Maxi relè 12 Volt
	<b>FB270.42CS</b>	70 Amp c/Diodo c/Staffa
	<b>FB12100CD</b>	100 Amp c/Diodo s/Staffa
	<b>FB120.12</b>	120 Amp
	<b>FB692.02</b>	50 Amp c/Resistenza s/Staffa

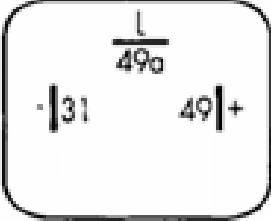

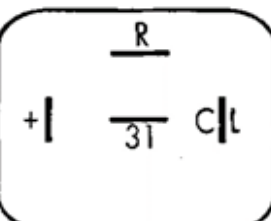



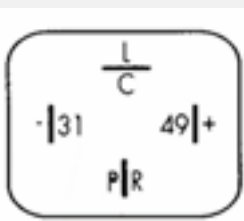

	<p><b>FB692.11</b></p> 	<p>70 Amp c/Resistenza s/Staffa 87341931 692.10</p>
	<p><b>FB692.21</b></p> 	<p>70 Amp 504053413 692.20</p>
	<p><b>FB692.80</b></p> 	<p>80 Amp Avviamento scooter Piaggio</p>
	<p><b>FB22200117A</b></p> 	<p>70 Amp c/Diodo c/Staffa</p>
	<p><b>FB180.12N</b></p> 	<p>180 Amp</p>
	<p><b>FB100/150</b></p>	<p>Maxi relè 12V 100/150 Amp</p>
	<p><b>FB10700005</b></p> <p>Stecksocket (Elfenbein) Socket (Beige)</p>	

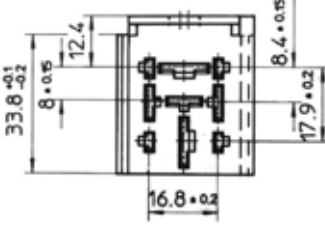
	<p><b>FB127010</b></p> 	<p>80/100 Amp c/Diodo s/Staffa</p>
	<p><b>FB270.50</b></p> 	<p>60/70 Amp c/Diodo c/Staffa</p>
	<p><b>FB272.52</b></p> 	<p>60/70 Amp c/Diodo s/Staffa</p>
	<p><b>FB12112</b></p> 	<p>80/100 Amp</p>
	<p><b>FB200</b></p> 	<p>12V 200Amp</p>

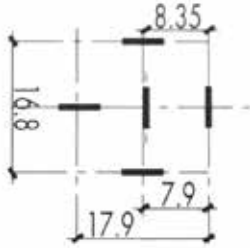
	<p><b>FB387.91</b></p> 	<p>OEM 500028304 Fiat Bravo/Brava VW Golf 42/46WX2</p>
	<p><b>FB387.93</b></p> 	<p>OEM 500028304 Fiat Bravo/Brava VW Golf 42/46WX2 Maserati</p>
	<p><b>FB387.96</b></p> 	<p>OEM 500028304 Fiat Bravo/Brava VW Golf 42/46WX2</p>
	<p><b>FB424</b></p> 	<p>7595406 New Holland Fiat 42/46Wx2</p>
	<p><b>FB610.30</b></p>	<p>Alfa Romeo 145-146 Alfa164 2(4)X21w</p>
	<p><b>FB627</b></p>	<p>42/46WX2 Fiat Punto Lancia Y Bravo Brava con antidisturbo radio</p>
	<p><b>FB012</b></p> 	<p>2(4)X21W+4W Fiat 127 Diesel (brasile)</p>

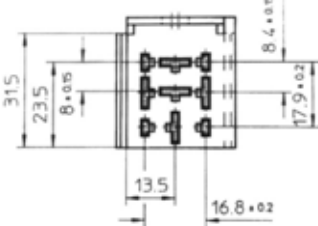
	<b>FB379</b>	Lampeggiatore Daily 12 V 4800836 Iveco Daily 12v
	<b>FB10012712</b>	flip flop 12v 2x150w
	<b>FB10012724</b>	flip flop 24v 2x150w 69500432
	<b>FB30386</b>	Lampeggiatore a filo caldo 12V 12V 21WX2+5W MAX.47W 040315
	<b>FB446.10</b>	<div data-bbox="491 1323 756 1541" style="border: 1px solid black; padding: 5px; display: inline-block;"> <math display="block">\frac{L}{490}</math> <math display="block">- 31 \quad 49 +</math> </div> 67/47W
	<b>FB311</b>	Lampeggiatore 12V

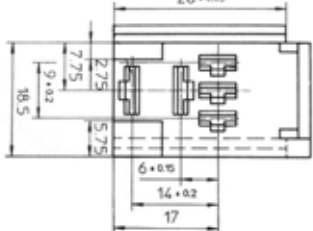
	<b>FB10700005</b> Portarelè Maxi	Stecksocket (Elfenbein) Socket (Beige)	
	<b>FB26100</b> Portarelè Standard	Blocchetto volante 5 vie Per femmine (6,35x0,8)mm Terminal block 5 ways for female terminals	
	<b>FB10485008</b> Portarelè ISO	Stecksocket Socket	
	<b>FB10700004</b> Blocchetto portarelè Micro	Stecksocket Socket	

### Combinazioni possibili Portarelè ad incastro















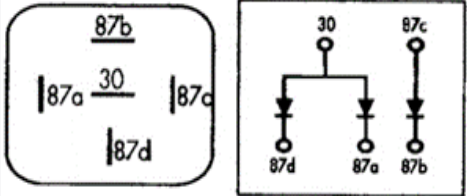

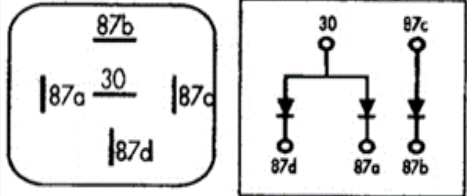
	<b>FB476</b>	<p>7244021 7664763 7726125 46428175 5973754 59737540 5973757 75896560 76647630 7765674 4RV 008</p> <p>Fiat - Fiorino, Panda, Ritmo</p>
	<b>FB4060</b>	<p>60812527 46772573 46438546</p> <p>1.9 TD 75 S (182.BF) Bravo I (182) Fiorino Kasten (146) Fiorino Pick up (146)</p>
	<b>FB812</b>	<p>598116 598119 598125 598131 598138 598143</p> <p>2.0 D Multijet 20 MULTIJET DAL 2007 SCUDO Combinato (220P) 1,9 D SCUDO Combinato (220P) SCUDO Combinato (220P) SCUDO Combinato (220P) SCUDO Combinato (220P)</p>
	<b>FB814</b>	<p>55557760 51799044 1232077</p> <p>Opel Corsa D 1,3 CDTI DA 07--2006--&gt;</p> <p>Opel 1232076 Opel 55557760</p>
	<b>FB813</b>	<p>Opel 55557761 Opel 1232077 Opel Astra J Corsa D Meruiva B 12/2009--&gt; Tutti Multijet Fiat</p>
	<b>FB815</b>	<p>Centralina new Opel astra 1232077 - 51799045</p> <p>55557761</p>

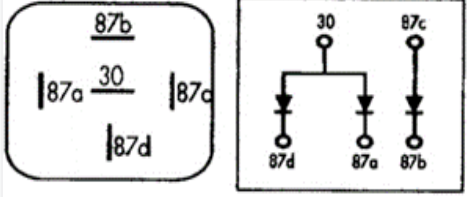
	<p><b>FB816</b></p>	<p>55353011 Opel 6235240 Opel</p>	<p>AGILA A AGILA B ASTRA G ASTRA H COMBO TIGRA VECTRA 1,3 CDTI 1,9 CDTI 2,2 DTI</p>		
	<p><b>FB818</b></p>	<p>9640469680A 9640469680 93858431 11067JD50A 4416764 OPEL 9640469680</p>	<p>CITRO BERLINGO FIAT GM NISSAN MOVANO 2,5 CDTI--VIVARO COMBI RENAU MASTER 2 BUS2,5 DCI--TRAFIC 2</p>		
	<p><b>FB819</b></p>	<p>038907281D 281003038 5033351AA 4805510 038907281D 038907281D</p>	<table border="1"> <tr> <td data-bbox="868 804 948 949"> <p>AUDI BOSCH CHRIS OPEL SEAT VW</p> </td> <td data-bbox="959 804 1422 949"> <p>A1-(8X1,8XF) 1.6 TDI-A3 281003040 281003041-2810033083  Altea 19 TDI--Ibiza-Leon Toledo-Fabia-2002--&gt;2011 Amarok Caddy III (2KA.2HK.2CA.2CH)-Golf VI-Tiguan</p> </td> </tr> </table>	<p>AUDI BOSCH CHRIS OPEL SEAT VW</p>	<p>A1-(8X1,8XF) 1.6 TDI-A3 281003040 281003041-2810033083  Altea 19 TDI--Ibiza-Leon Toledo-Fabia-2002--&gt;2011 Amarok Caddy III (2KA.2HK.2CA.2CH)-Golf VI-Tiguan</p>
<p>AUDI BOSCH CHRIS OPEL SEAT VW</p>	<p>A1-(8X1,8XF) 1.6 TDI-A3 281003040 281003041-2810033083  Altea 19 TDI--Ibiza-Leon Toledo-Fabia-2002--&gt;2011 Amarok Caddy III (2KA.2HK.2CA.2CH)-Golf VI-Tiguan</p>				
	<p><b>FB820</b></p>	<p>A0005453616 A0195456932 A0255452932 A0285454032 A6489000000 A6489000100</p>	<p>Classe c CLK CLASSE E CLASSE G VITO-SPRINTER DAL 2002-&gt;2013 VIANO</p>		
	<p><b>FB821</b></p>	<p>51799030A A0005453516 A0255452832 A6461536579 A6461538491</p>	<p>WEHRLE CLASSE A -Vaneo-CLASWSE C-E--VIANO 2.0 CDI VITO 109CDI -SPRINTER 2-3 4 E 5 -T</p>		
	<p><b>FB822</b></p>	<p>038907281B 281003085 038907281B 038907281B 038907281B</p>	<table border="1"> <tr> <td data-bbox="932 1816 1011 1951"> <p>AUDI BOSCH VW SEAT VW</p> </td> <td data-bbox="1023 1816 1445 1951"> <p>A3(8V1)-16TDI-20-A4(8E2.B6) A5(8TA)-A6(4F5.C6) Q5(8R)-TT-  ALHAMBRA(710)-EXEO (3R2)-LEON-OCTAVIA-BEETLE CC GOLF V GOLF VII-PASSAT (362) TRASPORTER</p> </td> </tr> </table>	<p>AUDI BOSCH VW SEAT VW</p>	<p>A3(8V1)-16TDI-20-A4(8E2.B6) A5(8TA)-A6(4F5.C6) Q5(8R)-TT-  ALHAMBRA(710)-EXEO (3R2)-LEON-OCTAVIA-BEETLE CC GOLF V GOLF VII-PASSAT (362) TRASPORTER</p>
<p>AUDI BOSCH VW SEAT VW</p>	<p>A3(8V1)-16TDI-20-A4(8E2.B6) A5(8TA)-A6(4F5.C6) Q5(8R)-TT-  ALHAMBRA(710)-EXEO (3R2)-LEON-OCTAVIA-BEETLE CC GOLF V GOLF VII-PASSAT (362) TRASPORTER</p>				

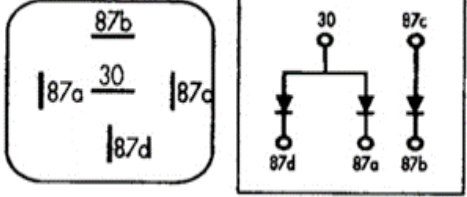
	<b>FB244045</b>	92515867 Citroen AX C15		
	<b>FB51233001</b>	Seat Ibiza Toledo-19D VW Golf II-Golf III Passat Variant-Vento dal 91  VW 171911261		
	<b>FB60299008</b>	G. Cartier 9633610280		
	<b>FB51299018A</b>	1237976	GM OPEL	55354141 6235303 ASTRA G ASTRA H-17CDTI(F35)-COMBO KASTEN CORSA CMERIVA-VECTRA ZAFIRA
	<b>FB51751001</b>	Pre a thing relè 12V		
	<b>FB637.11</b>	98411034 Iveco Daily standard su aspirato 8 Optional su turbo 10 Optional su turbo 10		

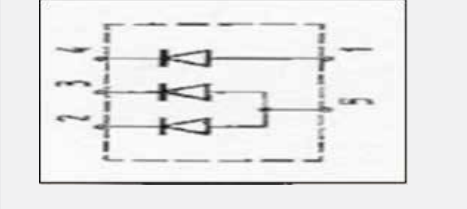

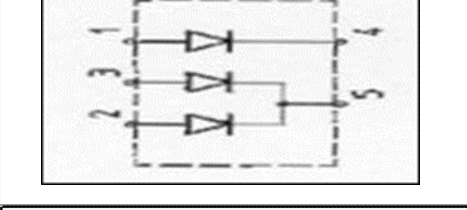
	<b>FB240101</b>	960754406 PSA 192949 Citroen:Evasion e Jampy 30-20 AMPER FIAT ULISSE 9607540680 FIAT PEUGEOT 106-306-405-605-
	<b>FB240103</b>	7731751 46414326 Fiat:Cinquecento , Punto
	<b>FB240104</b>	96196965 96271095 PSA Citroen:Xsantia Xm Xsara
	<b>FB240107</b>	96271096 Citroen: Berlingo Evasion Xsantia Fiat: Scudo Lancia: Zeta
	<b>FB240109</b>	96299459 PSA Fiat:Ulisse 2000TD Peugeot: 206 106 306
	<b>FB240113</b>	500309839 7767971 Fiat: Bravo marea Palio Iveco:Daily 35.11

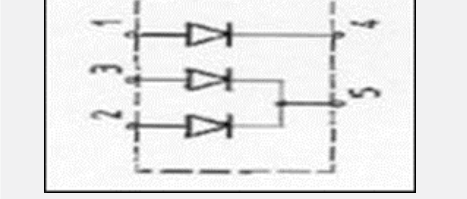
	<p style="text-align: center;"><b>FB331.10</b></p> 	<p>47298581</p>
	<p style="text-align: center;"><b>FB331.20</b></p> 	<p>504044788</p>
	<p style="text-align: center;"><b>FB333.10</b></p> 	<p>Codice equipaggiamento: 4740157 3 Diodi 3 Ampere Max</p>
	<p style="text-align: center;"><b>FB454</b></p> 	<p>64875214 CONTENITORE DIODI SPIE E RELAYS SINO AD 1 AMPER</p>
	<p style="text-align: center;"><b>FB546.10</b></p> 	<p>9843 8334 3 DIODI 3A - 1000V</p>
	<p style="text-align: center;"><b>FB546.20</b></p> 	<p>9843 8336 3 DIODI 3A - 400V</p>
	<p style="text-align: center;"><b>FB546.30</b></p> 	<p>9843 8337 3 DIODI 3A - 1000V</p>



**FB546.40**

1 Diodo 3 A - 1000V  
2 Diodi 1 A - 400V

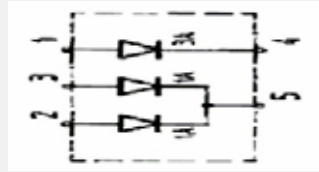

9843 8338



**FB546.60**

4 DIODI 3A - 1000V

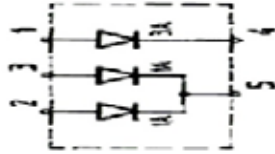

9843 8339



**FB546.70**



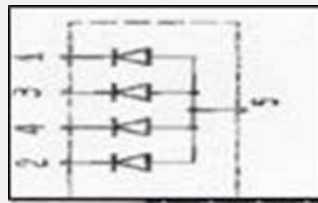



4 DIODI 1A - 400V



9843 8340

	<b>FB532</b>	
	<b>FB621</b>	
	<b>FB638</b>	8284173 Centraline IGE Lancia Kappa Nuova Alfa 164
	<b>FB669</b> 	
	<b>FB713</b>	46480968 Centraline ABI
	<b>FB747</b>	46550225 FIAT BRAVO BRAVA Centraline ABI

	<b>FB661</b>	BRAVA PUNTO PANDA LANCIA Y
	<b>FB663</b>	Alfa: 145-146 Lancia: Delta(primissima dal 1990->) Fiat:Uno Ritmo
	<b>FB724</b>	CENTRALINA TETTO APRIBILE LANCIA LIBRA SW
	<b>FB438</b>	Intermittitore Tergi vecchia Fiat Tipo
	<b>FB665</b>	
	<b>FB547</b>	

	<b>FBR12</b> MULTITIMER 12V 20 AMPER
	<b>FBT15</b> 12V 15 SECONDI 20 AMPER
	<b>FBT60</b> 12V 60 SECONDI 20 AMPER
	<b>FBR24</b> Multitimer 24V regolabile
	<b>FB313</b> INTERMETTITORE TERGI 12V GM Con asservimento alla pompa tergicristallo <div style="border: 1px solid black; border-radius: 10px; padding: 5px; width: fit-content; margin: 10px auto;"> <p style="text-align: center;">15</p> <p style="text-align: center;">31   31b   53c</p> <p style="text-align: center;">     53e</p> </div>
	<b>FB565</b> 90458988 Relay Temporizzato 15 MINUTI GM Opel <div style="border: 1px solid black; border-radius: 10px; padding: 5px; width: fit-content; margin: 10px auto;"> <p style="text-align: center;">87</p> <p style="text-align: center;">E   87a   31</p> <p style="text-align: center;">15     30</p> </div>
	<b>FB587</b> Relay Temporizzato 15 Minuti GM GM Opel 904 57986 12V 20 Amper <div style="border: 1px solid black; border-radius: 10px; padding: 5px; width: fit-content; margin: 10px auto;"> <p style="text-align: center;">87</p> <p style="text-align: center;">E   87a   31</p> <p style="text-align: center;">15     30</p> </div>

**FB418**

Interruttore Tergi 12V

**FB346**

Commutatore 4 Vie

**FB346.10**

Commutatore 4 Vie

**FB346.20**

Commutatore 4 Vie

**FB324**

Interruttore

**FB326**

Interruttore Iveco

**FB325.50**

Interruttore Iveco

4799227

**FB353.10**

Interruttore Iveco

4799223

	<b>FB2140/2</b> 12V 140 AMPER	<p>Indicato dove sono montate due batterie, servizi e avviamento.</p> <p>Si installa a monte delle due batterie e stacca la batteria di avviamento quando avverte un calo di tensione di 12V</p>
	<b>FB2140/1</b> 12V 140 AMPER Marinizzato	<p>Indicato dove sono montate due batterie, servizi e avviamento.</p> <p>Si installa a monte delle due batterie e stacca la batteria di avviamento quando avverte un calo di tensione di 12V</p>
	<b>FB1118</b> 24 VOLTS 40 AMPER	<p>Indicato dove sono montate due batterie, servizi e avviamento.</p> <p>Si installa a monte delle due batterie e stacca la batteria di avviamento quando avverte un calo di tensione di 12V</p>
	<b>FB1117</b> 12 VOLTS 80 AMPER	<p>Indicato dove sono montate due batterie, servizi e avviamento.</p> <p>Si installa a monte delle due batterie e stacca la batteria di avviamento quando avverte un calo di tensione di 12V</p>

## Dimensioni

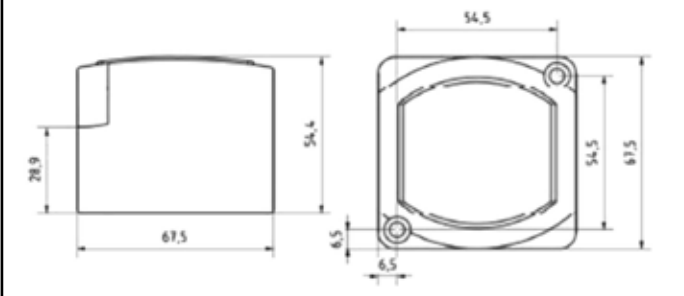

## Schema per veicoli con 1 batteria

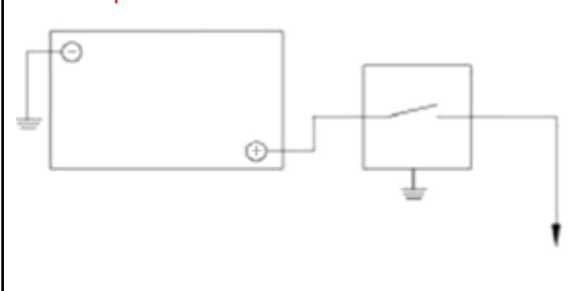

## Schema per veicoli con 2 batterie

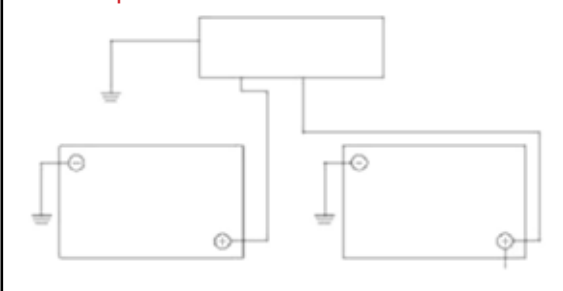



**FB9277**

**Display information**  
**Display Information**

## Schemi

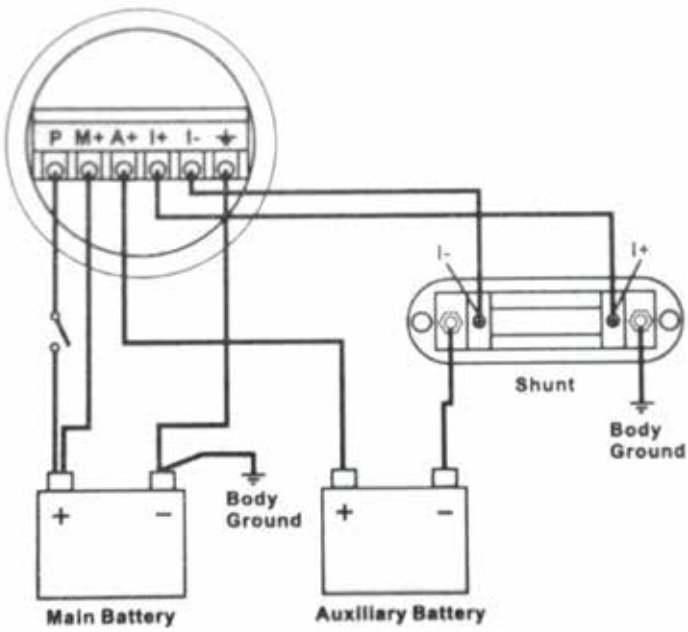

## Montaggio

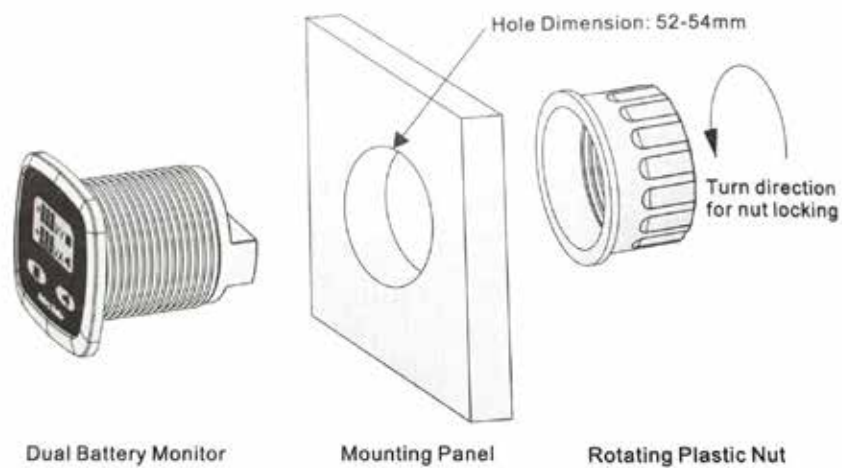

	<b>FB236</b> 	<b>9491030 SEGNALATORE ACUSTICO</b> Iveco Fiat Geotech Astra Rif.4762124 4830834
	<b>FB315</b>	<b>SEGNALATORE ACUSTICO</b>
	<b>FB229</b>	<b>SEGNALATORE ACUSTICO 24 Volts</b>

	<b>FB736059</b> SEGNALATORE ACUSTICO 12 V SPEGNIMENTO LUCI
	<b>FB654</b> CENTRALINA COMPRESSORE PUNTO I SERIE DIESEL
	46410806
	<b>FB654.10</b> CENTRALINA COMPRESSORE PUNTO I SERIE BENZINA
	<b>FB671</b> RITARDATORE ELETTROVENTOLA BRAVO BRAVA MAREA
	Iveco Gamma S 2000
	<b>FB514</b> SEGNALATORE ACUSTICO INTERMITTENTE CINTURE DI SICUREZZA
	<b>FB536.10</b> SEGNALATORE ACUSTICO CONTINUO 12V
	<b>FB536</b> SEGNALATORE ACUSTICO INTERMITTENTE 12V

	<b>FBAC235</b>	Presa di corrente
	<b>FBAC236</b>	Presa di corrente filettata
	<b>FBAC332</b>	Accendisigaro universale completo 12v
	<b>FBAC338</b>	Accendisigaro universale completo 24v
	<b>FBAC342</b>	Accendisigaro universale completo 12v rosso



**Truck Parts**

**Componenti elettrici ed elettronici**

Electric and electronic components



 **MAGNA**  
MAGNA ELECTRONICS

 **BLOCH  
STEM**

 **S.I.D.A.T.**

**VDO**

**LIFT  
TEK**

 **ELECTRIC-LIFE**  
TOTAL QUALITY

**MAGNETI  
MARELLI** **RICAM**

	<b>FB769.30</b> 50441124 - 504096743	<p>100E17 TECTOR RESTYL. 100E18 TECTOR RESTYL. 100E21 E.FIRE RESTYL. 100E21 TECTOR RESTYL. 120E17 TECTOR RESTYL. 120E21 TECTOR RESTYL. 140E18 TECTOR RESTYL. 140E21 TECTOR RESTYL. 140E24 E.FIRE RESTYLIN 140E24 TECTOR RESTYL. 140E28 E.FIRE RESTYLIN 140E28 TECTOR RESTYL. 150E21 TECTOR RESTYL. 150E24 TECTOR RESTYL. 160E21 TECTOR RESTYL. 160E24 TECTOR RESTYL.</p> <p>160E28 TECTOR RESTYL. 180E21 TECTOR RESTYL. 180E24 TECTOR RESTYL. 180E28 TECTOR RESTYL. 260E28 TECTOR RESTYL. 75E13 TECTOR RESTYLING 75E15 TECTOR RESTYLING 75E17 TECTOR RESTYLING 75E18 TECTOR RESTYLING CC100E21 TECTOR RESTYL CC150E24 TECTOR RESTYL</p>
	<b>FB769.20</b> 504096745 SOSTITUISCE 504041123	<p>100E17 TECTOR RESTYL. 100E18 TECTOR RESTYL. 100E21 TECTOR RESTYL. 120E17 TECTOR RESTYL. 120E21 TECTOR RESTYL. 130E18 TECTOR RESTYL. 130E21 TECTOR RESTYL. 140E18 TECTOR RESTYL. 140E21 TECTOR RESTYL. 140E24 TECTOR RESTYL. 140E28 TECTOR RESTYL. 160E21 TECTOR RESTYL. 160E24 TECTOR RESTYL. 160E28 TECTOR RESTYL. 180E24 TECTOR RESTYL. 180E28 TECTOR RESTYL.</p> <p>75E13 TECTOR RESTYLING 75E15 TECTOR RESTYLING 75E17 TECTOR RESTYLING 75E18 TECTOR RESTYLING</p>
	<b>FB768</b> 500392255 SOSTITUITO DA 500363455	<p>100E17 TECTOR 100E18 TECTOR 100E21 EUROFIRE TECTOR 100E21 TECTOR 120E17 TECTOR 120E21 TECTOR 130E18 TECTOR 130E24 EUROFIRE TECTOR 130E24 TECTOR 130E28 TECTOR 140E24 EUROFIRE TECTOR 140E28 EUROFIRE TECTOR 150E18 TECTOR 150E24 EUROFIRE TECTOR 150E24 TECTOR 1,50E28 EUROFIRE TECTOR</p> <p>150E28 TECTOR 180E21 TECTOR 180E24 TECTOR 180E28 TECTOR 260E28KE TECTOR 320E28T TECTOR 75E13 TECTOR 75E15 EUROFIRE TECTOR 75E15 TECTOR 75E17 EUROFIRE TECTOR 75E17 TECTOR 75E18 TECTOR CC100E18 TECTOR CC100E21. TECTOR CC130E24 TECTOR CC150E24 TECTOR</p>
	<b>FB0288724</b> 5801926287	<p>I.B.C.3-L.O. IVECO BODY CONT.3 - MY 2015</p> <p>150E28W DVD MY 2015</p>
	<b>FB0288734</b> 5801926285	<p>I.B.C.3-B.L. IVECO BODY CONT.3 MY 2015</p> <p>100E18 MY 2008 100E18 MY 2013 100E19 E6 100E21 E6 100E22 E6 100E22 MY.2008 110E22 MY.2013 110E22IN E6 110E22W MY.2008 120E18 MY.2008 120E19 E6 120E21 E6 120E22 E6 120E22 MY.2008 140E18 MY.2008 140E19 E6</p> <p>140E21 E6 140E22 E6 140E22 MY.2008 140E22 MY.2013 140E25 EC 140E25 MY.2008 140E28 E6 150E18 MY.2008 150E22 MY.2008 150E22 MY.2013 150E24 MY.2013 150E25 MY.2008 150E25W E6 150E25W MY.2008 150E28W E6 150E28W MY.2008</p> <p><i>+ codici sul sito</i></p>
	<b>FB0288744</b> 5801926270	<p>I.B.C.3 - H.L.IVECO BODY CONT.3 - MY2015</p> <p>100E18 MY.2008 100E18 MY.2013 100E19 EE6 100E19 MY2015 100E21 E6 100E21 MY2015 100E22 E6 100E22 MY.2008 100E22 MY2015 110E18 MY.2016 110E22 MY.2013 110E22W E6 110E22W MY.2008 110E22W MY2015 120E18 MY.2008 120E18 MY.2016</p> <p>120E19 E6 120E19 MY2015 120E21 E6 120E21 MY2015 120E21 CNG MY 2015 120E22 E6 120E22 MY.2008 120E22 MY.2016 170E22 MY2015 1,40E1.8 MY.2008 140E19 E6 140E1.9 MY2015 140E21 E6 140E2.1 MY2015 140E22 E6 140E22 MY.2008</p> <p><i>+ codici sul sito</i></p>



<b>FB0288640</b>	504300983
<b>FB0288630</b>	504300982



<b>FB0288632</b>	<b>M.E.T. MODULO ELETTR.TELAIO B.L. MY2013</b>
5801583468	EX 5801362428 EX 504300982 EX 504097627 100E18 MY.2013 100E19 E6 100E19 MY2015 100E21 E6 100E21 MY2015 100E22 E6 100E22 MY2015 110E18 MY 2016 110E22 MY 2013 110E22W E6 110E22W MY2015 120E19 E6 120E19 MY2015 120E21 E6 120E21 MY2015 120E21CNG MY2015 120E22 E6 120E22 MY2015 140E19 E6 140E19 MY2015 140E21 E6 140E21 MY2015 140E22 E6 140E22 MY.2013 140E22 MY.2016 140E22 MY2015 140E24 MY.2016 140E25 F6 140E25 EUROFIRE E6



<b>FB0288642</b>	<b>M.E.T. MODULO ELETTR.TELAIO H.L. MY2013</b>
5801583467	190T31 AD TRAKKER E6 190T33 AD TRAKKER E6 190T33 AT TRAKKER E6 190T36 AD TRAKKER E6 190T36 AT TRAKKER E6 190T41 AD TRAKKER E6 190T41 AT TRAKKER E6 190T45 AD TRAKKER E6 190T45 AT TRAKKER E6 260T33 AD TRAKKER E6 260T33 AT TRAKKER E6 260T36 AD TRAKKER E6 260T36 AT TRAKKER E6 260T41 AD TRAKKER E6 260T41 AT TRAKKER E6 260T45 AD TRAKKER E6 260T45 AT TRAKKER E6 260T50 AD TRAKKER E6 340T36 AD TRAKKER E6 340T36 AT TRAKKER E6 340T40 AD TRAKKER E6 340T41 AD TRAKKER E6 340T41 AT TRAKKER E6 340T45 AD TRAKKER E6 340T45 AT TRAKKER E6 340T30 AD TRAKKER E6 340T50 AT TRAKKER E6 380T36 AD TRAKKER E6 380T41 AD TRAKKER E6 380T41 AT TRAKKER E6 380T45 AD TRAKKER E6 260T45 AT TRAKKER E6 260T50 AD TRAKKER E6 340T36 AD TRAKKER E6 340T40 AD TRAKKER E6 340T41 AD TRAKKER E6 340T41 AT TRAKKER E6 340T45 AD TRAKKER E6 340T45 AT TRAKKER E6 340T30 AD TRAKKER E6 340T50 AT TRAKKER E6 380T36 AD TRAKKER E6 380T41 AD TRAKKER E6 380T41 AT TRAKKER E6 380T45 AD TRAKKER E6



<b>FB890.00</b>	<b>504055356</b>
	<b>BED MODULE - STRALIS AT/AD</b>
	100E18 MY.2008 100E18 MY.2013 100E19 E6 100E19 MY2015 100E21 E6 100E21 MY2015 100E22 E6 100E22 MY.2008 100E22 MY2015 110E18 MY.2016 110E22W E6 110E22W MY.2008 120E18 MY.2008 120E18 MY.2016 120E19 F6 120E19 MY2015 120E21 E6 120E21 MY2015 120E22 E6 120E22 MY2008 120E22 MY2015 140E18 MY2008 140E19 E6 140E19 MY2015 140E21 E6 140E21 MY2015 140E22 E6 140E22 MY.2008 140E22 MY.2013 140E22 MY.2016 140E22 MY2015 140E25 E6



<b>FB0289001</b>	<b>5801974075</b>
	<b>BED MODULE - STRALIS AT/AD</b>
	190S31 AT STRAL.MY2016 190S33 AT STRAL.MY2016 190S36 AT STRAL.MY2016 190S40 AT STRAL.MY2016 190S42 AT STRAL.MY2016 190S46 AT STRAL.MY2016 190S48 AT STRAL.MY2016 260S31. AT STRAL.MY2016 260S33 AT STRAL.MY2016 260S36 AT STRAL.MY2016 260S40 AT STRAL.MY2016 260S42 AT STRAL.MY2016 260S46 AT STRAL.MY2016 260S48 AT STRAL.MY2016 260X46 AT X-WAY 260X48 AT X-WAY 320S46 AT STRAL.MY2016 320S48 AT STRAL.MY2016 440S33 AT STRAL.MY2016 440S36 AT STRAL.MY2016 440S40 AT STRAL.MY2016 440S42 AT STRAL.MY2016 440S46 AT STRAL.MY2016 440S48 AT STRAL.MY2016 440X42 AT X-WAY 440X46 AT X-WAY 440X48 AT X-WAY



<b>FB0289010</b>	<b>5801630629</b>
	<b>BED MODULE - STRALIS AT/AD</b>
	190S42 AS STRAL.MY2013 190S42 AS STRALIS E6 190S46 AS STRAL MY2013 190S46 AS STRALIS E6 190S48 AS STRALIS E6 190S50 AS STRAL MY2013 190S50 AS STRALIS E6 260S42 AS STRAL MY2013 260S42 AS STRALIS E6 260S46 AS STRAL MY2013 260S46 AS STRALIS E6 260S48 AS STRALIS E6 260S50 AS STRAL MY2013 260S50 AS STRALIS E6 260S56 AS STRAL MY2013 260S56 AS STRALIS E6 320S50 AS STRAL MY2013 320S50 AS STRALIS E6 320S56 AS STRALIS E6 440S40 AS STRAL.CNG E6 440S42 AS STRAL MY2013 440S42 AS STRAUS E6 440S43 AS STRAL MY2013 440S46 AS STRAL MY2013 440S46 AS STRALIS E6 440S48 AS STRAL MY2013 440S48 AS STRAL E6 440S50 AS STRAL MY2013 440S50 AS STRALIS E6 440S54 AS STRAL MY2013 440S56 AS STRAL MY2013 440S56 AS STRALIS E6

**FB717.10** RIDUTTORE TENSIONE PER RIMORCHIO 24V

500376972

**FB689** 504219479

Riduttore di tensione 24V-12V

3 Uscite separate

10,5 AMPER

100E19 E6  
100E19 MY2015  
100E21 E6  
100E21 MY2015  
100E22 E6  
100E22 MY2015  
110E22W E6  
110E22W MY2015  
120E19 E6  
120E19 MY2015  
120E21 E6  
120E21 MY2015  
120E21CNG MY2015  
120E22 LO  
120E22 MY2015  
140E19 E6

140E19 MY2015  
140E21 E6  
140E21 MY2015  
140E122 E  
140E72 MY 2015  
140E25 E6  
140E25 EUROFIRE 1E6  
140E25 MY2015  
140E28 E6  
140E28 MY2015  
150E25 E6  
150E25W MY2015  
150E28 MY2015  
150E28W E6  
150E28W MY2015  
150E32 MY2015

+ codici sul sito

**FB689.30** 504219480

Riduttore di tensione 24V-12V

20 AMPER

140E25 EUROFIRE MY2008  
150E25W E.FIRE MY2005  
150E30W ERRE MY2008  
160E30 EUROFIRE MY2008  
190S27 AD STRAL.CNG E6  
190S27 AD-CNG STRALIS  
190S30 AD STRAL.CNG E6  
190S31 AD STRAL.2007  
190S31 AD STRAL.MY2013  
190S31 AD STRALIS E6  
190S31 STRAL.2007  
190S31 AT STRAL.MY2013  
190S31 AT STRAL.MY2016  
190S31 AT STRALIS E6  
190S33 AD STRAL.2007  
190S33 AD STRAL.CNG E6

190S33 AD STRAL.MY2013  
190S33 AD STRAL MY2016  
190S33 AD STRALIS E6  
190S33 AD-CNG STRALIS  
190S33 STRAL 2007  
190S33 AT STRAL.CNG E  
190S33 AT STRAL.MY2  
190S33 AT STRALIS MY2016  
190S33 AT STRALIS E6  
190S36 AD STRAL  
190S36 AD STRAL  
190S42 AS STRAUS [6  
190S42 AT STRAL.2007  
190S42 AT STRAL.MY2013  
190S42 AT STRAL.MY2016  
190S42 AT STRALIS E6

+ codici sul sito

**FB1119** Riduttore di tensione 12V 3Amp**FB1120** Riduttore di tensione 12V



	<b>FB028400</b> Centralina Gread Header  New Hollan Mc Cormick  Iveco - 504034977
	<b>FB672.30</b> 500363042  Temporizzatore Stop Elettromagnete  
	<b>FB463</b> lampeggiatore statico 24/50W 4839806
	<b>FB607.20</b> Lampeggiatore statico 24/50W 4839806 500321679 - 500372850 4852650 Caratteristiche tecniche: Lampeggiatore statico per veicoli industriali (possibilità di utilizzo anche per veicoli privi di rimorchio)
	<b>FB804.10</b> Steerin Wheel Interface 1.1 41221141
	<b>FB607.20</b> + <b>FBCABL</b> Modifica per lampeggiatore  (Vecchi IVECO)



**FB786800** 504108682



**FB786810** Devio Daily S 2000 Base + CL  
504108685



**FB786851** Devio daily 2000-->2006 con cruise  
504108726







**FB786860** 504108890  
Devio Daily S 2000 Cruise + CL



**FB796502** devio daily 2006--> no air bag 69500207



**FB796512** Devio Daily s 2006-->cruise 69500430

	<b>FB796602</b>	Devio Daily s 2006-->cruise 69500434
	<b>FB796612B</b>	Devio Daily s 2006-->cruise 69500432
	<b>FB787502</b>	Leva sx D.G. S 2000 Ric Valeo  42568514
	<b>FB787500</b>	Leva sx S 2000  42568501
	<b>FB796306</b>	LEVA SX DAILY DAL 2006-->  42568498



**FB308000** EUROTECH EUROCARGO  
60/75/80/100/120/130/150 Completo

Adattabile  
990081401



**FB308001** EUROTECH EUROCARGO  
60/75/80/100/120/130/150

ADATTABILE  
990081429



**FB308002** IVECO EUROTECH LEVA TERGI  
93194120

ADATTABILE  
5008968



**FB308003** EUROTECH EUROCARGO  
93194120

ADATTABILE  
5008336



**FB308005** 93194120 EUROTECH EUROCARGO  
LEVA LUCI

79413





















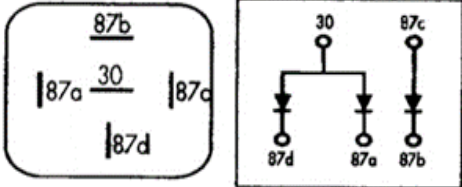

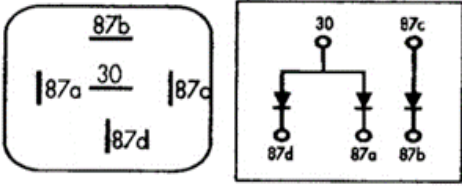
**FB30569** Devioguidera

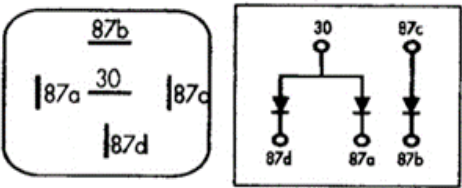

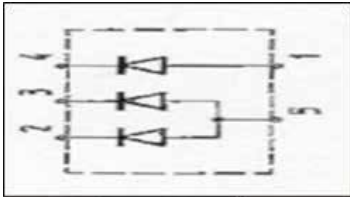
Grande Punto (199) 1.3 Mjet  
Punto Evo

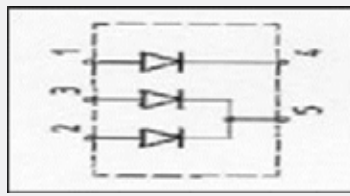
Valeo 251625

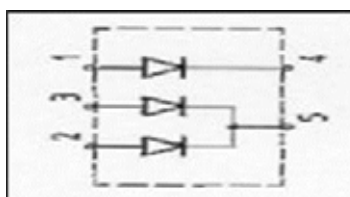

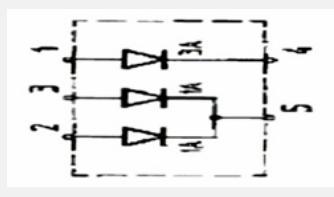
7355213115 Abarth  
735471936 Fiat  
735410423 Lancia

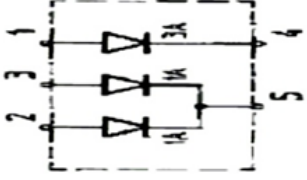
	<p><b>FB30604</b> Devioguida</p> <p>App. Panda (312, 323) in produzione Lancia Y (846) 5,2011 in poi 2012 in poi.</p> <p>Fiat 735529510 Fiat 735558307 Fiat 735576327</p> 
	<p><b>FB30603</b> Devioguida</p> <p>Chrysler sostituisce cod. 735576326 Fiat Panda Lancia Y</p> <p>Fiat 7356221860</p> 
	<p><b>FB30654</b></p>
	<p><b>FB769522</b></p>
	<p><b>FB308006</b> INTERRUPTORE EMERGENZA 9 PIN</p> <p>5011177 5004194 500388626 OEM 4840891</p>  <p><b>FB308008</b> INTERRUPTORE EMERGENZA 5 PIN</p> 
	<p><b>FB308007</b></p> <p>interruttore alzacristalli</p>

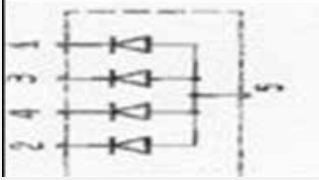
	<p><b>FB331.10</b></p> 	<p>47298581</p>
	<p><b>FB331.20</b></p> 	<p>504044788</p>
	<p><b>FB454</b></p> 	<p>64875214 CONTENITORE DIODI SPIE E RELAYS SINO AD 1 AMPER</p>
	<p><b>FB546.10</b></p> 	<p>3 DIODI 1000 WATT 98438334</p>
	<p><b>FB546.20</b></p> 	<p>3 DIODI 3 AMPER 400 VOLT 98438336</p>
	<p><b>FB546.30</b></p> 	<p>98438337</p>
	<p><b>FB546.40</b></p> 	<p>1 Diodo 3 Ampere 1000V 2 Diodi 1 Ampere 400V 98438338</p>

	<p><b>FB546.60</b></p> 	<p><b>4 DIODI 3 AMPER 1000V</b></p> <p>98438339</p>
	<p><b>FB546.70</b></p> 	<p><b>4 DIODI 1 AMPER 400V</b></p> <p>98438340</p>

Portaresistori

	<p><b>FB732</b></p>	<p><b>Portaresistori eco power</b></p> <p>500334927</p>
	<p><b>FB732.10</b></p>	<p><b>Portaresistori eco power</b></p> <p>500339358</p>
	<p><b>FB732.20</b></p>	<p><b>Portaresistori eco power</b></p> <p>500339358</p>

	<b>FB619</b>	Dispositivo chiusura centralizzata 98439364
	<b>FB538</b>	Intermittenza tergicristallo 24 V 500369986
	<b>FB548.60</b>	<b>INTERRUPTORE TACHIMETRICO</b> 99458468
	<b>FB678</b>	adattatore elettronico 98438337
	<b>FB678.10</b>	adattatore elettronico TACHIMETRICO 98438338
	<b>FB635.10</b>	98411035 Eurocargo tutti tipi Eurotek 8300 Eurotracker 8210 Eurostar8210
	<b>FB817.20</b>	Centralina elettronica Iveco 24V 504077826





**FB828.RES**

10/15 Amp c/Resistenza s/Staffa

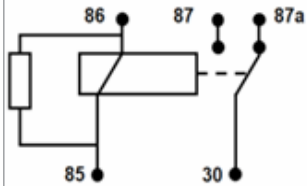

**FB9292**



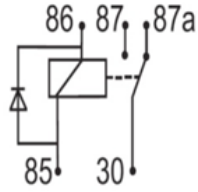





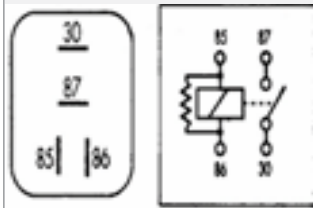

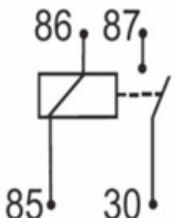

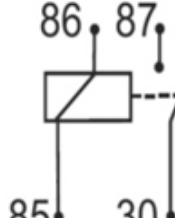
5/10 Amp = 29401041 c/Diodo s/Staffa

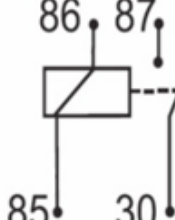

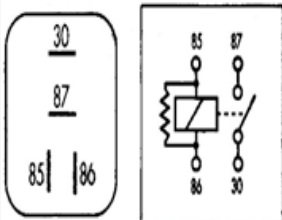

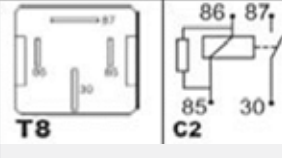

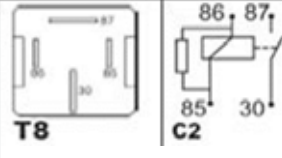
**FB420.N41**

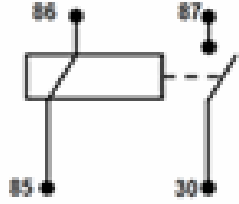
10 Amp c/Resistenza s/Staffa

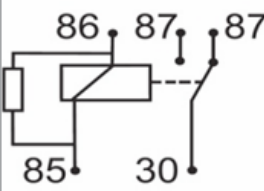

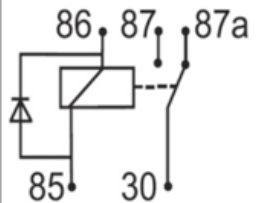







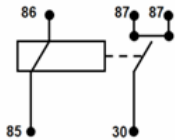

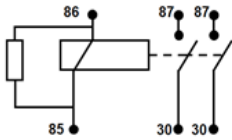

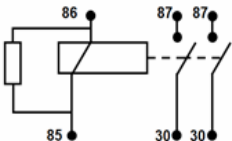

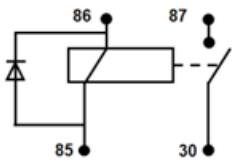

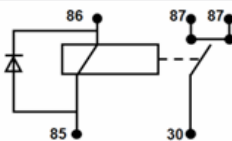

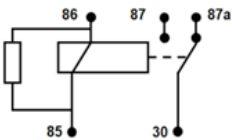

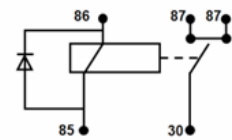

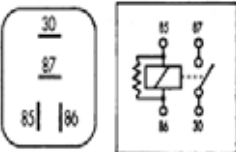



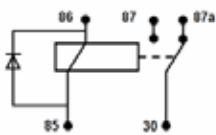

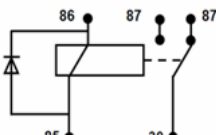

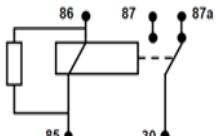
	<b>FB60.24</b> 	60 Amp c/Staffa
	<b>FB80.24</b> 	80 Amp c/Staffa
	<b>FB100.24</b> 	100 Amp c/Staffa
	<b>FB442.41</b> 	40 Amp c/Resistenza s/Staffa
	<b>FB470.41</b> 	70 Amp c/Resistenza
	<b>FB2450R</b> 	50 Amp
	<b>FB150.200</b> 	150 Amp c/Staffa

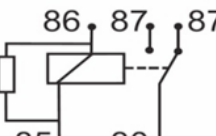
	<b>FB440.50</b> 	<b>30/40 Amp c/Resistenza c/Staffa</b>
	<b>FB442.52</b> 	<b>30/40 Amp c/Diodo</b>
	<b>FB243050NC</b>	<b>30/50 Amp</b>

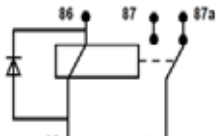
Mini relè iso 24V

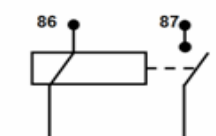
	<b>FB564.10</b>	<b>24V 20Amp</b>
---	-----------------	------------------

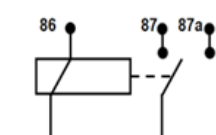
	<p><b>FB043CS</b></p> 	<p><b>30 Amp</b></p> <p>bosch 0 332 003 018 bosch 0 332 014 202-203- iveco 4718224</p>
	<p><b>FB06324</b></p> 	<p><b>15+15 Amp s/Staffa</b></p> <p>24 X 2 15 AMPER Doppio Contatto</p>
	<p><b>FB1116</b></p> 	<p><b>2x15 Amp</b></p> <p>Rele doppio contatto 24v 2x15</p>
	<p><b>FB430.42</b></p> 	<p><b>30 Amp c/Diodo c/Staffa</b></p>
	<p><b>FB700.20CD</b></p> 	<p><b>20 Amp c/Diodo c/Staffa</b></p> <p>Sostituito da FB043CD</p>
	<p><b>FB827</b></p> 	<p><b>20 Amp c/Diodo s/Staffa</b></p> <p>RELE N.A.24V 20AH-SOST.042-- 4718224</p>
	<p><b>FB043CD</b></p> 	<p><b>30 Amp c/Diodo</b></p> <p>Sostituisce il 700.20CD</p>
	<p><b>FB20401101</b></p> 	<p><b>10/20 Amp s/Staffa</b></p>

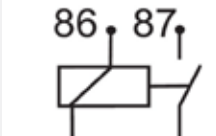
	<p><b>FB1114</b></p> 	<p>10/20 Amper c/Diodo s/Staffa</p> <p>Relè tenuta stagna</p>
	<p><b>FB700.20CDS</b></p> 	<p>10/20 Amper c/Diodo c/Staffa</p> <p>Sostituisce il FB03533</p>
	<p><b>FB700.20CS</b></p> 	<p>10/20 Amp c/Diodo</p>
	<p><b>FB700.30</b></p> 	<p>10/20 Amp c/Diodo s/Staffa</p>
	<p><b>FB700.50</b></p> 	<p>10/20 Amp c/Diodo s/Staffa</p>
	<p><b>FB724.24</b></p> 	<p>20 Amp c/Staffa</p>
	<p><b>FB796.10</b></p> 	<p>10/20 Amp</p>
	<p><b>FB699.10</b></p> 	<p>Relè 24V senza staffa</p> <p>Relay 24V 20 Ampere Senza staffa N.A.</p>



**FB3419**

Pompetta Lavavetro Daily 2000



**FB3407**

Pompa mono 24V

inn. vert + pack



# Componenti elettrici ed elettronici

Electric and electronic components



---

FBR SAS Di Ferrara Bruno &c  
Tel 0536-805508  
C.C.I.A.A. Modena 223159  
[www.fbr-ricambi.it](http://www.fbr-ricambi.it) p.i. 015355550360  
[commerciale@fbr-ricambi.it](mailto:commerciale@fbr-ricambi.it)  
[info@fbr-ricambi.it](mailto:info@fbr-ricambi.it)

---